

PLANOMAT XT

FLEXIBLE ADVANCED TECHNOLOGY
FOR YOUR PRODUCTION



PLANOMAT XT

DIMENSIONS

- 5 machine sizes with the following grinding ranges:
 - 400 × 800 mm
 - 400 × 1,200 mm
 - 600 × 800 mm
 - 600 × 1,200 mm
 - 600 × 2,000 mm¹⁾

HARDWARE

- C.O.R.E. Panel
- Fully modular system
- Design characteristics: very high rigidity, minimum vibrations, minimized thermal influences
- Precision linear guideways
- High quality, recirculating ballscrews
- Option: linear direct drive (X-axis)

SOFTWARE

- C.O.R.E. OS operating system
- Optimal operator guidance
- Programming with menu-guided grinding and dressing cycles
- UNITED GRINDING Digital Solutions™

¹⁾ coming soon



YOUR BENEFITS

- Intuitive, user-friendly, and efficient operation
- Access to important information directly at the control panel (e.g. production progress, task details, etc.)
- Reduced programming when exchanging data between C.O.R.E. machines
- Use of UNITED GRINDING Digital Solutions™ products directly on the machine
- Fast support thanks to direct interaction with our Customer Care team on the machine

«Higher axis speeds, higher accelerations and increased system rigidity – the combination of these improved influencing factors consistently leads to an increase in productivity while at the same time improving workpiece quality.»

C.O.R.E. – CUSTOMER ORIENTED REVOLUTION

C.O.R.E. helps us make your production fit for the digital future.

It's based on a new operating system, C.O.R.E. OS, that equips the machine with intelligence.

Thanks to the uniform C.O.R.E. software architecture, exchanging data between UNITED GRINDING machines is easy. The integrated umati API can be used to communicate with third-party systems as well. It also offers access to UNITED GRINDING Digital Solutions™ products directly on the machine. C.O.R.E. not only establishes the technical foundation for this and other IoT and data applications, it also forms the basis of revolutionary yet uniform operation.

What does this mean for you?

- The user-friendly, intuitive, and uniform operation makes work easier for machine setters, machine operators, and maintenance staff
- Standardized data collection and intelligent processing of data creates transparency and supports process optimization
- The uncomplicated and consistent use of modern digital software solutions is guaranteed – directly on the machine
- The technical platform for the use of modern IoT and data applications has been established

C.O.R.E. ELEMENTS

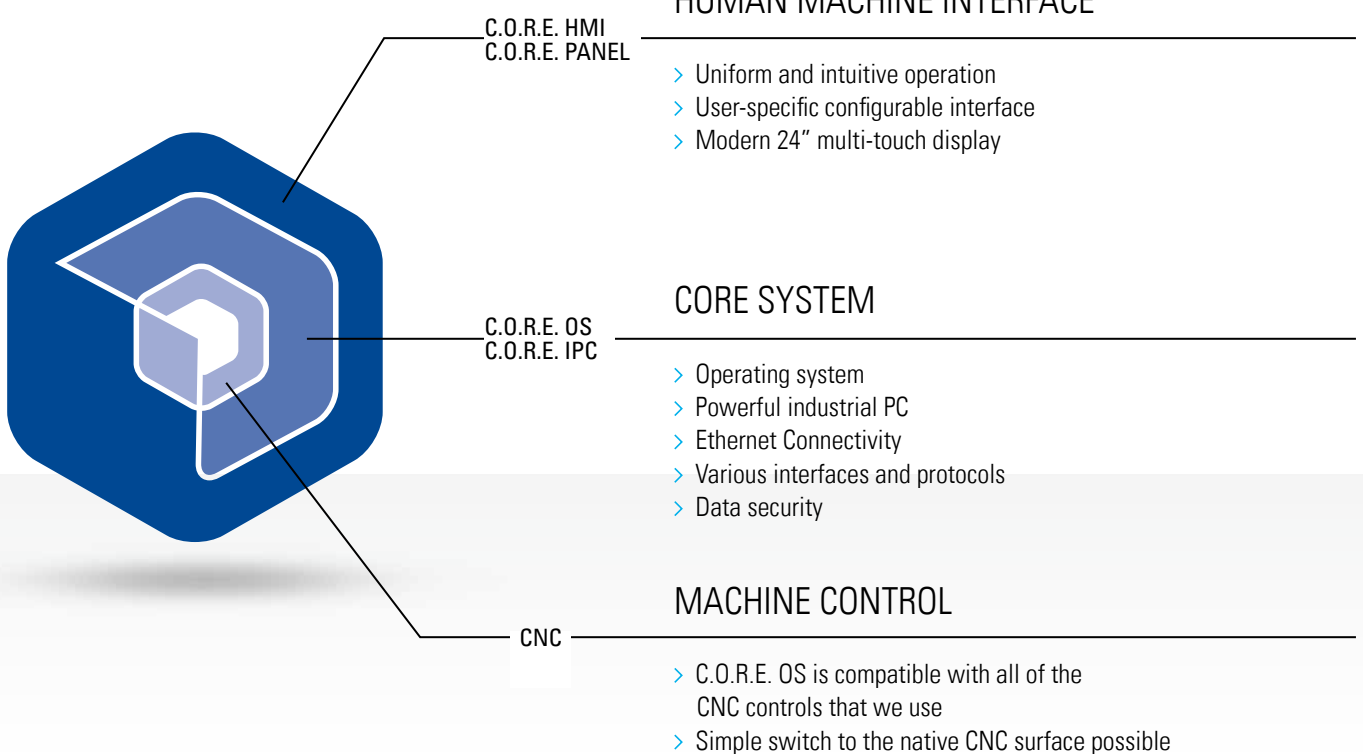

C.O.R.E. PANEL – THE FUTURE OF OPERATION

Intuitive

Thanks to intuitive design with self-explanatory icons, navigation through the machine menu and process steps is quick and easy. Instead of buttons, the user is presented with a modern and clearly arranged multi-touch display.

User-friendly

Each user configures their own user interface individually. This is called up automatically with the RFID chip after logging in. When the user leaves the machine, the panel switches to «Dark Factory Mode.» Production progress and the machine state are also clearly visible from a

distance. And thanks to the ergonomic design, the panel can be tilted and individually adjusted easily.

Efficient

The uniform and intuitive operating philosophy reduces training time. The configurable and role-specific interface helps prevent errors and increases the efficiency and quality of programming. Information can be exchanged quickly and in real-time via the front camera and Bluetooth headset. UNITED GRINDING Digital Solutions™ products can be used directly on the panel.

INDUSTRIAL MULTI-TOUCH DISPLAY

INTEGRATED FRONT CAMERA

SELF-EXPLANATORY ICONS

USER-CONFIGURABLE DISPLAY

STANDARDIZED FUNCTION KEYS

ERGONOMIC OVERRIDE SWITCH



Technical Specifications

- 24" Full HD multi-touch display
- 16-position rotary override switch
- Electronic key switch (RFID)
- Integrated front camera
- Bluetooth V4.0 headset connection
- 2x USB ports
- Adjustable tilt

WELL-PROVEN CONSTRUCTION PRINCIPLES

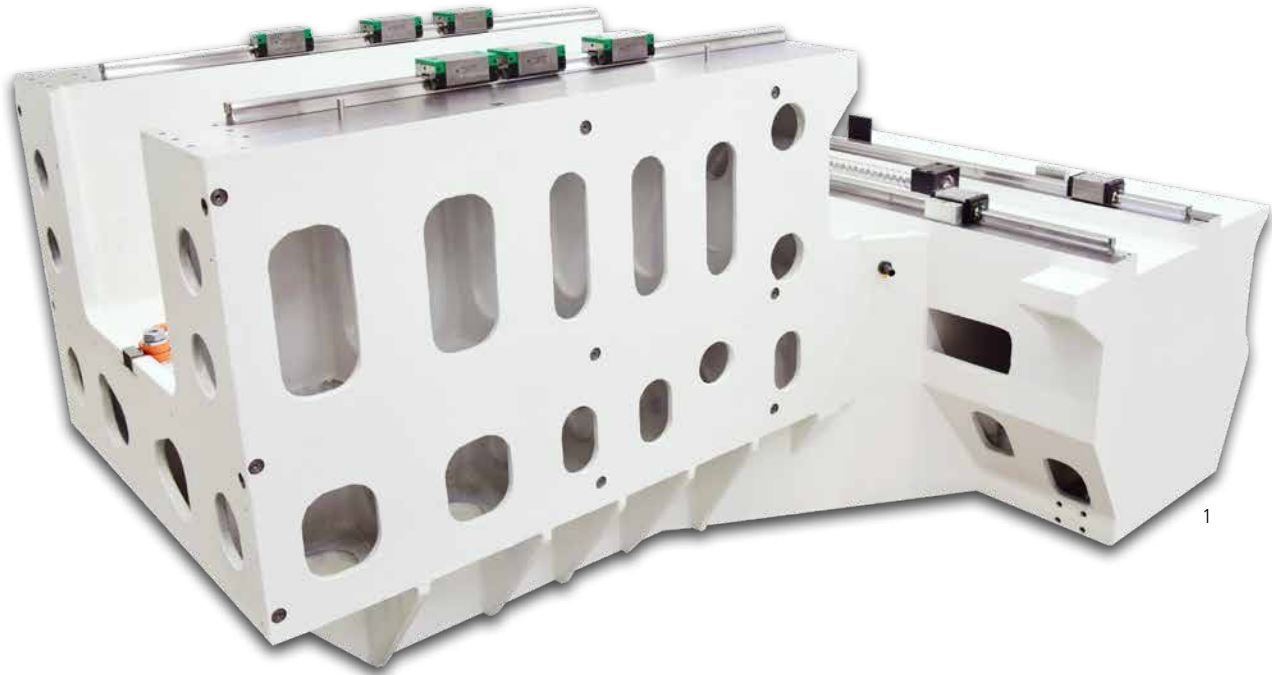

«The use of machine components specifically designed on the modular system ensures high precision and a long machine life.»

The PLANOMAT XT has been designed purely as a high performance surface and profile grinding machine for flexible applied technology. It offers the flexibility of a universal machine for single part production up to complex production tasks.

Grinding spindle drives up to 24.5 kW guarantee outstanding performance using conventional as well as all CBN grinding methods.

A large spectrum of standard accessories and special part clamping and part handling systems offer a quick and economic adaptation to customer specific production requirements at high quality.

- 1 Machine bed
- 2 Re-circulating ballscrew
- 3 Precision linear guideways

OPTIMUM DRESSING

By using process-optimized dressing methods, workpieces can be manufactured with high precision at short cycle times and with minimum grinding wheel wear.



▲ Table mounted dresser type PA-TL 200S for diamond rolls up to a width of 200 mm or for contour dressing with universal diamond dressing discs and a rough dressing disc.

The articulating dressing attachment PA-T130 enables continuous path controlled dressing by means of using the machine axes and the CNC controlled articulating axis of the dresser. The equipment includes an electronic measuring device with stand, probe and calibration ball.

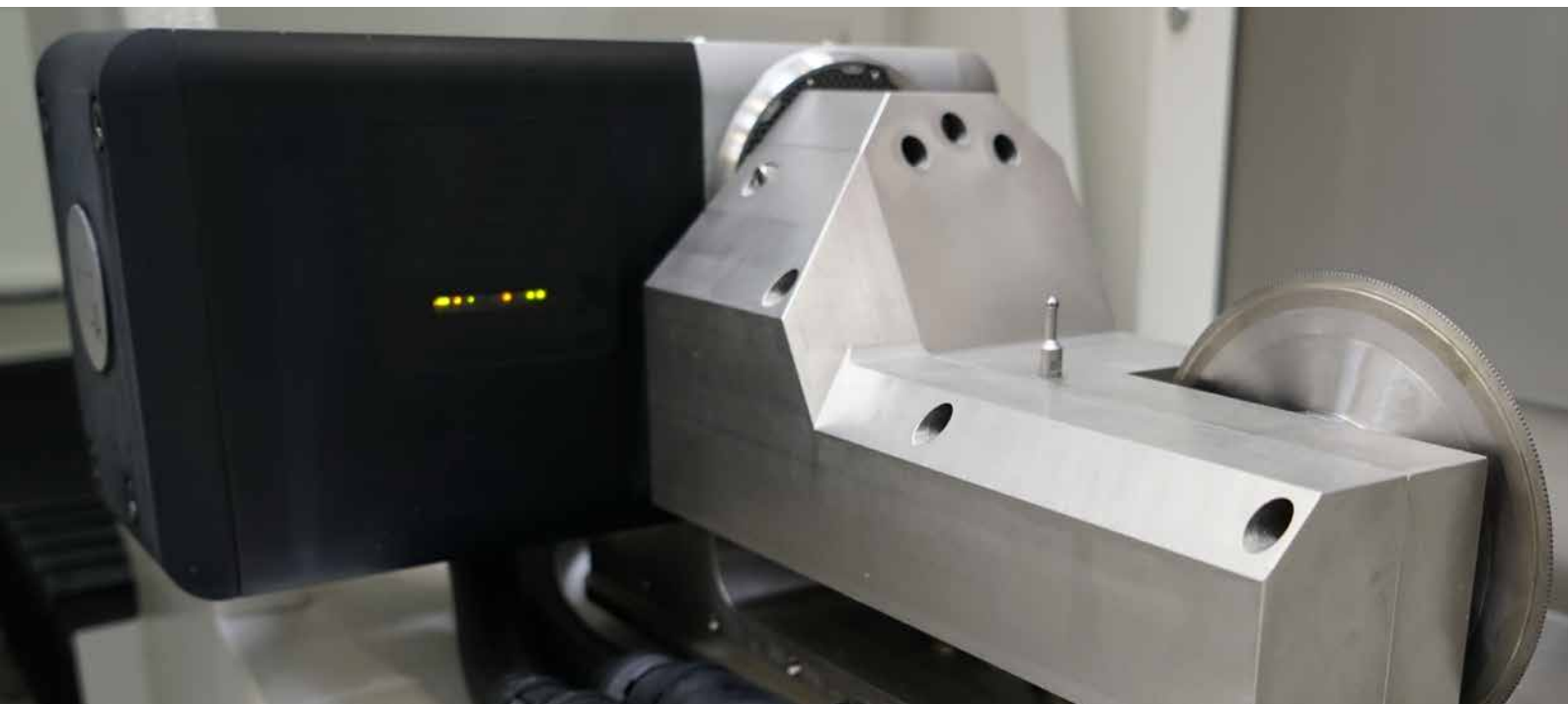

CNC CONTROLS



The comfortable solution for profile grinding applications

The best machines in a performance class offer more than just technically advanced components. Their high capabilities are made possible by the use of perfectly matched software and technology.

The CNC control Siemens Sinumerik 840D solution line with graphical operator guidance especially developed for grinding applications guarantees an optimal process. The simple programming is supported by menu guided grinding and dressing cycles.

The software option GripsProfile is a comfortable tool for the automatic generation of grinding and dressing programs, especially for the single piece and batch production.

KNOWN BLOHM USER INTERFACE

Basic data grinding wheel data



Grinding of a thread rolling die

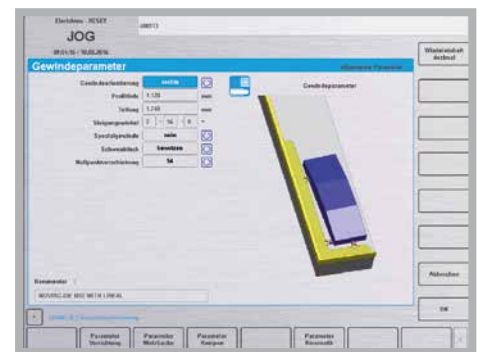

Taper grinding geometry data



Contour parallel dressing



APPLICATIONS

For grinding complex shapes in a wide variety of demanding materials, you need a flexible surface and profile grinding machine that delivers exceptional performance and efficiency. Manufacturers rely on innovative surface and profile grinding technology from BLOHM for a wide range of machining requirements, from creepfeed grinding to multi-step part production in a single setup. With the PLANOMAT XT, you get an

industry-leading solution for a wide variety of production environments and industries. A powerful drive and an advanced machine control ensure the highest level of reliability and precision in the production of your parts. To develop a specific surface and profile grinding solution tailored to your individual needs, our application engineers will be glad to work closely with your team.

- | | |
|----------------------|-------------------|
| 1 Piston rack nut | 7 Blade |
| 2 Sector shaft | 8 Vane |
| 3 Rocker arms | 9 Shroud |
| 4 Fin disc | 10 Hirth coupling |
| 5 Powder metal punch | 11 Chuck jaw |
| 6 Wood chipper blade | 12 Pump rotor |



1



2



3



4



5

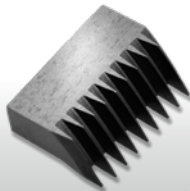

6



7



8



9



10



11



12

OPTIONAL TOOL CHANGER

The optional tool changer of the PLANOMAT XT enables the automated and largely unmanned operation for diverse grinding technologies. Increase your productivity by preparing, for example, roughing and finishing wheels or conventional and CBN wheels in the changer – this enables a high stock removal rate as well as the precise finishing of surfaces in one operation.

- Magazine with up to eight grinding wheels
- max. wheel diameter 400 mm¹
- max. wheel weight 40 kg
- max. wheel width 160 mm¹

¹) depending on total number of loaded wheels





2



3



4

Set-up during the process

The loading device enables easy and safe set-up of grinding wheels during production. This further reduces the set-up times.

Automation of production

The use of sister tools ensures continuous production in unmanned operation for complex workpieces.

- 1 Tool changer
- 2 Prepared grinding wheels
- 3 Loading device
- 4 Grinding wheel change

WE ARE HERE FOR YOU

Our products are designed to meet customer demands for as long as possible, they are intended to operate efficiently, reliably, and be available at any time.

From «Start up» through to «Retrofit» – our Customer Care is there for you throughout the working life of your machine. For this reason, you can rely on competent HelPLines worldwide and Service Engineers near you:

- We will provide you with fast, straight-forward support.
- We will help to increase your productivity.
- We work professionally, reliably and transparently.
- We will provide a professional solution to your problems.



Start up
Commissioning
Warranty extension

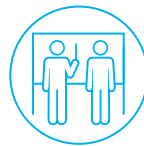

Qualification
Training
Production support



Prevention
Maintenance
Inspection



Service
Customer service
Customer consultation
HelPLine



Digital Solutions
Remote Service
Service Monitor
Production Monitor

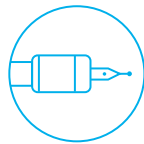

Material
Spare parts
Replacement parts
Accessories



Rebuild
Machine overhaul
Assembly overhaul



Retrofit
Modifications
Retrofits

UNITED GRINDING DIGITAL SOLUTIONS™

We develop solutions to support you in simplifying processes, boosting your machines' efficiency and increasing overall productivity under the UNITED GRINDING Digital Solutions™ brand. Find out more

about UNITED GRINDING Digital Solutions™ services on our website in the Customer Care section.

CUSTOMER CARE



TECHNICAL DATA

PLANOMAT XT		408	412	608	612	620 ¹
Grinding range	mm	400 × 800	400 × 1,200	600 × 800	600 × 1,200	600 × 2,000
Table clamping area with auxiliary surface	mm	400 × 1,300	400 × 1,700	600 × 1,300	600 × 1,700	600 × 2,500
Distance table to spindle center	mm	950				
X-axis, machine table longitudinal travel, max.	mm	1,100	1,500	1,100	1,500	2,300
Feed rate	mm/min	30 ... 40,000				
Y-axis, wheel head vertical travel	mm	800				
Feed rate	mm/min	4 ... 10,000				
Z-axis, column cross travel	mm	360	360	560	560	560
Feed rate	mm/min	4 ... 16,000				
Grinding spindle drive, variable speed, AC motor	kW/rpm	15/6,000 (option 24.5/6,000)				
Grinding wheel size (d × w × bore)	mm	400 × 100 × 127				
Dimensions width	mm	4,000	4,800	4,000	4,800	6,400
depth, incl. electr. cabinet and panel	mm	3,000	3,000	3,450	3,450	3,450
height	mm	2,970	2,970	2,970	2,970	2,970
Machine weight, incl. electrical cabinets	kg	7,300	7,700	7,500	9,000	10,800

We reserve the right to make technical changes
¹) coming soon

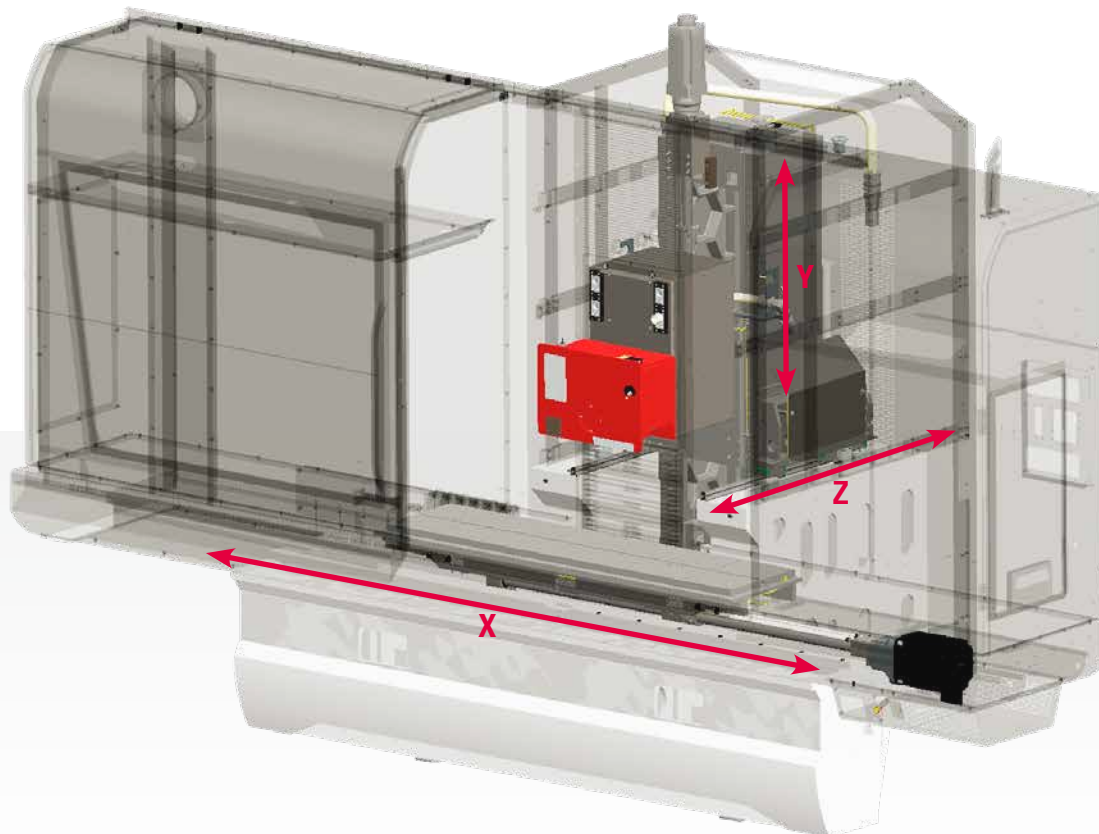

BLOHM JUNG GMBH

Productivity, performance and precision – three characteristics that users worldwide associate with the surface and profile grinding machines from BLOHM and JUNG. Our machines have been in use worldwide for decades in widely varying fields of application and under the most diverse conditions. The experience gained from more than 35,000 machines delivered is constantly incorporated into further developments and innovations to increase the production efficiency of our customers even further.

The product portfolio of Blohm Jung GmbH ranges from surface grinding machines to application-oriented universal machines and customer-oriented production machines. Our service and technology special-

ists support our customers throughout the entire life cycle of the machines. From grinding tests through training and maintenance contracts to retrofits, we offer our customers prompt and personal advice.

In 2008, the two established brands BLOHM and JUNG merged under one roof. Blohm Jung GmbH thus bundled the extensive know-how and enables new, higher standards in the field of precision, quality as well as economic efficiency. As part of the UNITED GRINDING Group and with a network of worldwide representatives, Blohm Jung GmbH guarantees a global presence and proximity to the customer.



ABOUT US

UNITED GRINDING GROUP

UNITED GRINDING Group is one of the world's leading manufacturers of precision machines for grinding, eroding, laser, measuring and combination machining. With around 2,500 employees at more than 20 production, service and sales sites, the Group is organized in a customer-oriented and efficient way.

With its brands MÄGERLE, BLOHM, JUNG, STUDER, SCHAUDT, MIKROSA, WALTER, and EWAG as well as competence centers in America and Asia UNITED GRINDING offers an ample range of application expertise, an extensive product portfolio and an array of services for surface and profile grinding, cylindrical grinding and tool machining. In addition, a competence center for additive manufacturing is operated under the IRPD brand.

«We want to make our customers even more successful»

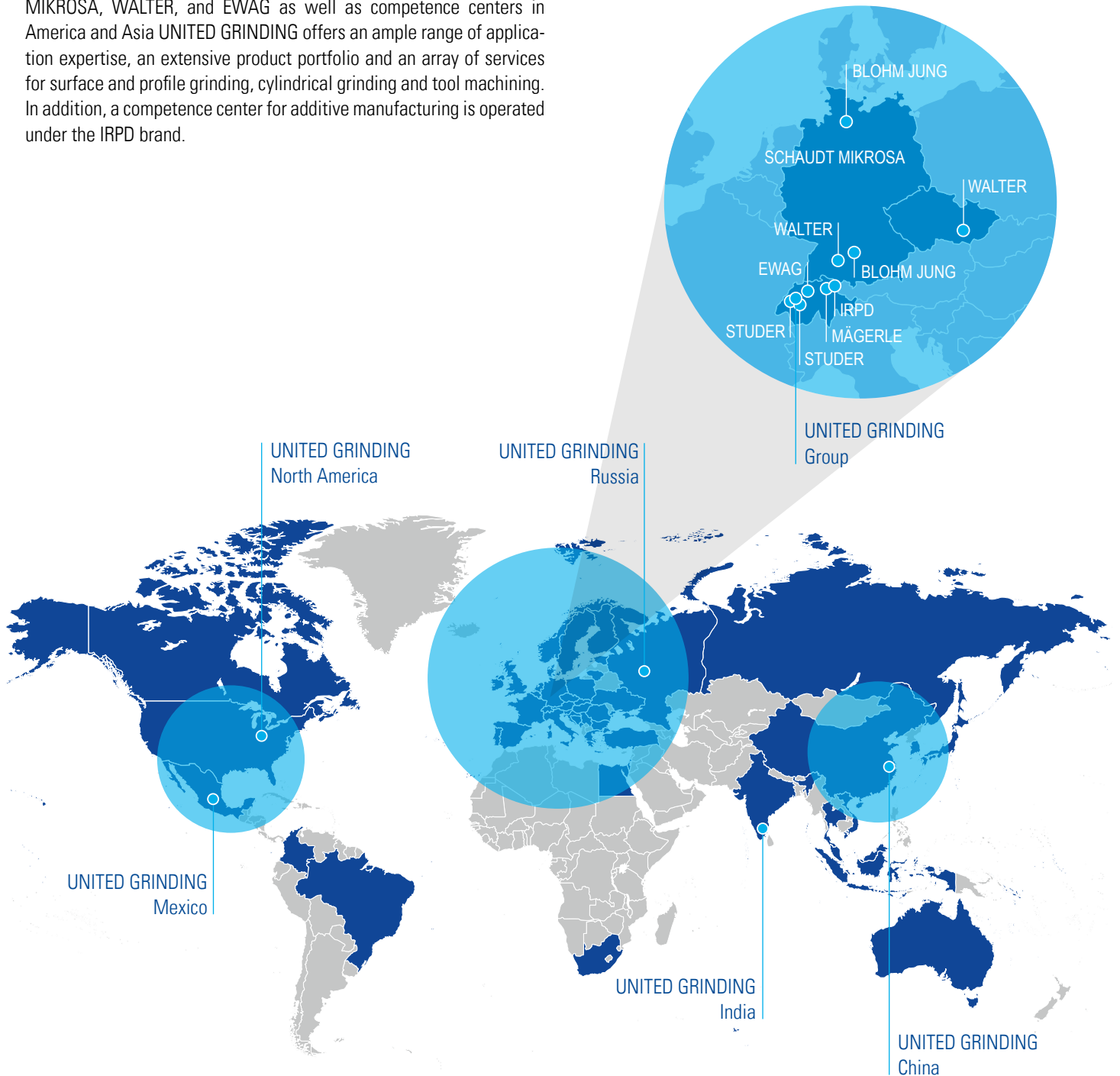



Blohm Jung GmbH

Location Hamburg
Kurt-A.-Körber-Chaussee 63-71 · 21033 Hamburg, Germany
Phone +49 40 33461 2000
sales-hh@blohmjung.com

Location Göppingen
Jahnstraße 80-82 · 73037 Göppingen, Germany
Phone +49 7161 6271 800
sales-gp@blohmjung.com

Please find worldwide contact information on
blohmjung.com

